



# St. Matthew's United Methodist Church



## The ParishScope



Join us . . . St. Matthew's Facebook Concert

We will be featuring the wonderful duo of **Randy Guiaya** and **Billy Burke** as part of St. Matthew's UMC livestream virtual FB concert on **Sunday, Oct. 25, 2020 at 5:00pm.**

With a friendship and musical partnership that has spanned over 3 decades, Billy and Randy have been described as "musical bookends" by their colleagues and fans. Together, they've worked as church musicians at *St. Gregory's Catholic Church* in Los Angeles, *Trinity Baptist Church* in Santa Monica and *Our Mother of Good Counsel* in Los Feliz (where they currently serve as co-directors). In addition, they were members of *Witness*, a Los Angeles based choral ensemble which travelled to Ukraine, Moscow, Northern Ireland London and China.

Billy is a graduate of *CSU Long Beach* with a degree in Industrial Design. Randy graduated from the *USC Thornton School of Music*. He currently is a music teacher and stage, screen and voiceover artist.

ST. MATTHEW'S UNITED  
METHODIST CHURCH  
PRESENTS

**STAY HOME** WITH  
**BILLY BURKE  
& RANDY GUIAYA**

**SUNDAY, Oct. 25, 2020 - AT 5:00PM**  
WATCH LIVE STREAMING AT: [www.facebook.com/pg/Stmatts1](http://www.facebook.com/pg/Stmatts1)  
For more info: (626) 333 - 6656  
#STAYHOME - #STAYSAFE - #ENJOYMUSIC

## St. Matthew's Receives Permission for Outdoor Spiritual Events

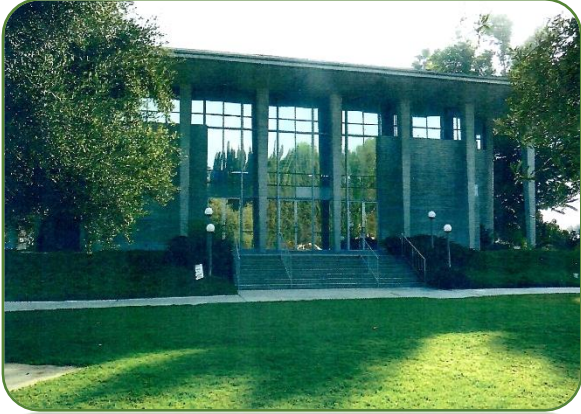

St. Matthew's has just received permission to hold outdoor spiritual events. Under the guidelines of the State of California, indoor worship is not possible at the present time for churches located in Los Angeles County. However, outdoor gatherings are possible. In addition to fulfilling state and county guidelines, St. Matthew's also had to submit a written plan for outdoor gatherings of more than 10 people for approval by United Methodist Church leadership in our area. On September 29, St. Matthew's written plan for outdoor spiritual gatherings was approved. Watch e-mails and Sunday announcements for information about upcoming events.

The approved plan allows for a variety of outdoor spiritual events in a variety of locations. It is now possible to hold outdoor gatherings of more than 10 people for:

- a Bible study
- a memorial service
- a special worship service such as Christmas Eve
- other events with a spiritual focus

These gatherings could either be:

- on the front lawn of the church
- on paved area between the Fellowship Hall and the Office Building

Jesus commands us to love our neighbor as ourselves. So it is important for us to protect each other in case someone is sick with COVID-19 but does not have symptoms and/or does not know that they're sick. So, people will be strongly encouraged to bring their own chairs and shade coverings from home to the outdoor spiritual gatherings. (However, some chairs will be available for those who don't bring chairs from home.) Face coverings will be required. Family groupings will be seated in ways to maintain social distancing between each family grouping. The church custodian will be on duty to disinfect the restrooms in the Fellowship Hall between uses.

Some have asked why the church doesn't move all the Sunday morning worship service outdoors. Right now the church does *not* have the ability to do an outdoor worship service online. The church needs to continue offering worship online for the many people who can only come online. Some are shut-ins. Others live too far away to come in person. And some are very reluctant to come to any kind of large gathering until there is a vaccine. So, church leadership believes that overall the best way is to continue online worship each Sunday while expanding our spiritual offerings to include outdoor Saturday events about once a month. Perhaps as we learn more about all the details involved in having an outdoor spiritual gathering, we can figure out the tech issues that would let us to effectively share such an outdoor service online.

## Remember Those Who Have Gone Before on All Saints Sunday, November 1<sup>st</sup>

Sunday, November 1 is All Saints Sunday. During the service on November 1, we will remember our loved ones who have passed during the last year.

This year the service may take on special meaning since because of COVID-19 so many memorial services have been either postponed or restricted to a few family members. The Worship Committee is working on special ways for people to participate in the All Saints Sunday Service from their homes. Watch the weekly announcements and e-mails for further information. Or, you can call the church office for updates.

On All Saints Sunday, loved ones will be remembered in several ways:

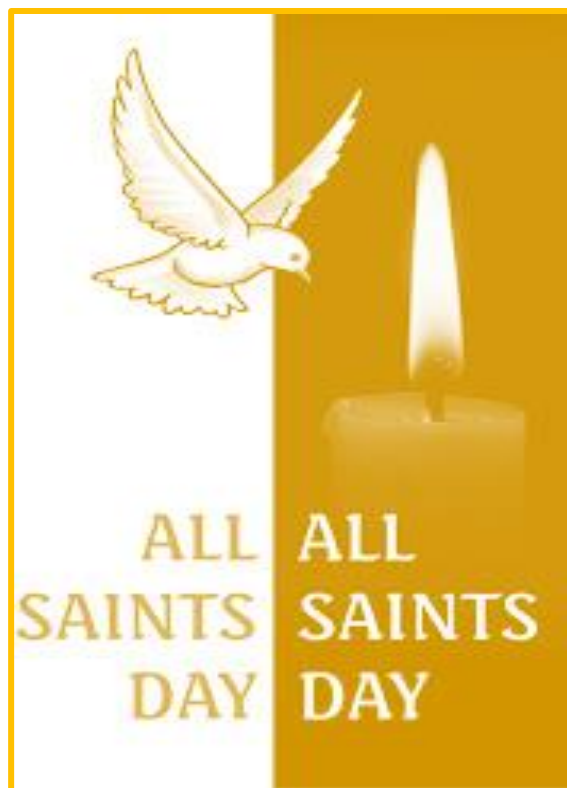

- *People connected to the church family who have died in the last year will be remembered during the service.* This includes people who have moved away but were part of the church family for many years and people who have become connected with St. Matthew's through online worship. To make sure everyone is included, please let Louise Green in the church office know by phone 626-333-6656 or e-mail [smumchh@gmail.com](mailto:smumchh@gmail.com). It is especially helpful if folks will contact the church office with the names of those who may have moved away but have been part of the church family for many years.
- *The church family is encouraged to share the names of loved ones – regardless of their connection with St. Matthew's – who have passed in the last year.* The names of these loved ones will be shared during the service. Such loved ones might include family, friends, neighbors, people who have had an impact on your life . . . . If you would like to add the name of a loved one to be shared during the service, please contact Louise Green in the church office by phone 626-333-6656 or e-mail [smumchh@gmail.com](mailto:smumchh@gmail.com).
- *During the service, there will be a time when people can remember in their hearts and/or homes the names of loved ones.* You do not need to contact anyone in advance to share these names. The service will include a time when people may choose to either silently lift up people's names in their hearts or say the names of loved ones out loud in their homes. Some may only remember people who have died in the last year. Others may included loved ones who have died many years ago.

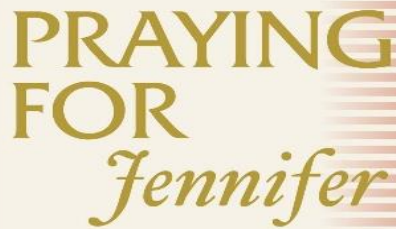

**PRAYING  
FOR  
*Jennifer***

**John Cobb Leads Discussion  
about Praying for Others  
on October 15<sup>th</sup> at 10:30 am**

John Cobb, the author of *Praying for Jennifer*, is leading a special class about intercessory prayer – praying for others – on Thursday, October 15<sup>th</sup> at 10:30 am. Everyone is encouraged to come and take advantage of this unique opportunity to gain a better understanding about how praying for others works. John Cobb is absolutely convinced that praying for others is powerful and important even when we do not fully understand how such prayers work. But he also thinks that developing a clearer understanding of how intercessory prayer works can help us pray for others more effectively.

The class promises to be stimulating and enlightening. It is *not* necessary to read *Praying for Jennifer* in order to come. But, reading *Praying for Jennifer* may help deepen one's insights and understandings of the conversation. It is particularly helpful to read chapters 4, 5 and 6. You can get the book through the church office or by ordering online.

In addition to writing *Praying for Jennifer*, John Cobb has written more than 50 other books in a variety of areas including theology, philosophy and sustainable environmental development. At least one historian has described him as one of the two most important North American theologians of the twentieth century.

The class will meet by Zoom. One of the advantages of gathering by Zoom is that people can come to the study even if the person only has a landline phone. So, you don't need to have a computer or the internet to come.

If you are coming by phone (i.e. you do not need a computer to come),

Dial: 1-669-900-6833

Meeting ID: 830 7535 1159#

If asked for a second ID: #

Password: 227517#

If you are coming by computer, tablet, . . . .

Go to <https://zoom.us/join>

Meeting ID: 830 7535 1159

Password: 227517

## Chairlift in Sanctuary Installed!

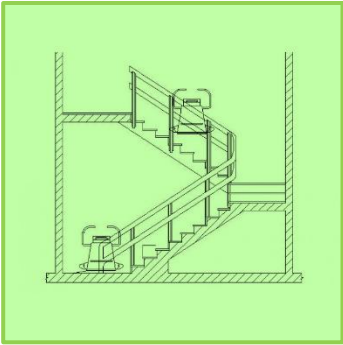

It's finally here! The long awaited chairlift in the sanctuary has been installed and is ready to go. Your Board of Trustees realized a long time ago that we needed a chairlift in the sanctuary. The chairlift is to assist our members who have difficulties going up and down stairs in getting to the basement restrooms. The chairlift has been in the planning stages for well over a year. Once we identified a company to do the work, we realized that the chairlift would work best in our sanctuary if two other projects were completed first.

In order to complete the chairlift project, the handrails on the stairs leading to the basement had to be modified to accommodate the chairlift. In addition, we had to install a new outlet to power the chairlift. Once these two projects were complete we were able to install the chairlift.

Thanks to Olga Baker and the memorials committee for ensuring that some of our memorial funds could be repurposed to the chairlift project. And, a huge thank you to the St. Matthew's members for participating in the matching grant challenge that ensured we had the necessary funds to complete this project.

If anyone is interested in learning how the chairlift works, please contact me at [rbrth87@gmail.com](mailto:rbrth87@gmail.com) to schedule a session to learn how the chairlift works.



Blessings,  
*Bob Hernandez*

## Car Parade on Sunday, October 18<sup>th</sup> at 5:00pm



On Sunday evening October 18<sup>th</sup>,  
St. Matthew's is having another Car Parade.

We will visit several people connected with the church family.

The car parade will start forming in the parking lot at 4:45 pm. (note new time). Bring your car – decorated or not. For the most part, folks will stay in their own cars. If for some reason someone needs to get out of their car, the church family expects the person to practice social distancing and wear a face mask. While we're waiting to leave, some may wish to add last minute decorations to their cars. Then, at 5:00 pm (note new time) we'll set out to visit people. We'll do our best to caravan together. But, maps and addresses will be provided just in case. At each home, we'll drive by slowly to have lots of time to honk, wave, smile, . . . Usually around 3 families are visited. The whole parade lasts less than an hour.

As we continue to live with the pandemic, a number of people are feeling cut off or isolated. Car parades help in two different ways. First, the parade provides an opportunity for folks who are parading in their cars to get out and see one another as well as those being visited. Second, the people being visited enjoy having “company” drive past their homes.

The church's understanding of who to visit is changing. People we used to think of as “shut-ins” are coming to church online every Sunday. Others who used to be able to come regularly in person to worship are finding the technology so challenging that they are not able to worship online. And yet others are in situations where concerns for their well-being mean that they seldom leave their homes or even see anyone from a distance.

St. Matts hopes to have a car parade each month. If you have suggestions of people to visit, contact the church office or Olga Baker.



## St. Matthew's Annual Charge Conference is Friday, November 20<sup>th</sup> at 3 pm

Charge Conference is our church's “annual meeting.” This year our charge conference will be at 3 pm on Friday, November 20<sup>th</sup> with our district superintendent, Rev. Melissa Roux MacKinnon presiding.

There will be one big difference with this year's charge conference. We will *not* meet in person at the church. Instead, we can meet from the comfort of our home (or work place) by Zoom.

During Charge Conference the congregation elects church leaders, takes stock of its ministry over the last year, and lays a foundation for the year ahead.

Church leaders are asked to get their charge conference reports to the church office by Monday, November 2<sup>nd</sup>. Submitting reports on time is a key part of making it possible for our secretary to organize and put together our charge conference book.



## News about St. Matthew's Preschool

As summer turns to fall the preschool is still navigating the ins and outs brought upon us by Covid 19. While we have not been able to take the final leap to reopen, we are by far not closing the book on this endeavor! We have taken this opportunity to get some work done while our student body is not on campus. We will continue to pursue ways of reopening including recruitment of families, advertisements, and grants to help offset the operating costs. Thank you to Bob Hernandez who is currently pursuing one such said grant.

Painting of the cabinets and cubbies has been done in 2 more of our classrooms by an Eagle Scout member, Justin Song. The final classroom is slated to be done in the near future. Also, we are much closer to a date to have the playground structure repaired. Pastor Richard has been working with various church members and a playground inspector to ensure this project gets taken care of before the reopening of the preschool to ensure our students' safety. Thank you Pastor Richard and Justin!

We are grateful to everyone for all the support and guidance that we have received during this difficult time. Please take a moment to visit the preschool website at [stmatthewsumcpreschool.org](http://stmatthewsumcpreschool.org) and see all the updates the website has undergone over the past few months. The more visits we get to the website the more often the preschool will pop up when area preschools are searched online!

*Blessings to All, Sherry Morales, Preschool Director*

## Preschool Playground Update

The overall plans for repairing the Preschool Play Structure are moving forward. Shortly before shutting down because of COVID-19, preschool leadership asked to have the Play Structure inspected to make sure it was safe for young children. The resulting inspection highlighted several critical repairs needed to keep children safe.

Despite the shut-down, the trustees and preschool have continued to move forward in developing a plan to make these repairs. Thanks to people's generosity in the matching gift campaign last spring, it is expected that enough funds are available to make all the needed repairs. Dick Cline has carefully studied the inspection report and 80+ pages of guidelines to develop drawings for what needs to be done. Marilyn McMullin has been working with Los Angeles County to get the necessary permissions to widen the entire play ground by moving the curb and fence to narrow the alley. This change will create a critically needed safe fall zone around the Play Structure. Terry Feulner has contacted a variety of contractors about doing the work. And, many others have contributed other important pieces needed to help finalize the plans.

The church is waiting to hear if it has gotten final permission from LA County to move the curb and fence. This may be the last permission piece that's needed. But there have been so many unexpected developments, those coordinating the project would not be surprised if something else turns up. If all goes well, construction to make the necessary repairs could start by early next year.





## Musical Notes from Elaine Ono, Director of Music

We will be featuring Kevin Massin, violinist, as our soloist during our Worship Service on Sunday, Oct. 18, 2020. Kevin is a native of Glendale, California. He started learning violin at his local elementary school in fourth grade. This was followed not long after with learning viola, cello and contrabass. It was not until his high school years where he truly found his passion for music through his music director, Mrs. Amy Rangel. He has also studied under Tamsen Beseke, the inventor of the famous shoulder rest "Acoustifoam", and Elizabeth Hedman from Pasadena City College on both violin and viola. Kevin helps his local middle school, Roosevelt Middle School, as their assistant music director and string technician. Kevin has also participated in a wide set of orchestras throughout the years such as Crown City Symphony, West Coast Symphony and Numi Opera, and Filipino American Symphony Orchestra. This is Kevin's first year as a transfer student to CSUN, pursuing his Bachelor of Music in Violin/Viola Performance, studying with Lorenz Gamma.



## St. Matthew's Continues to Assist People in Rebuilding Their Lives After Wild Fires and Hurricanes

St. Matthew's is continuing to take donations for UMCOR in helping people and communities that are impacted by recent natural disasters around our country begin the process of healing. This includes:

- Wild fires in the West, especially California
- Hurricanes in the Gulf Coast Region

UMCOR (United Methodist Committee on Relief) specializes in helping people rebuild their lives and their communities. UMCOR often spends years in communities working on long-term recovery projects. 100% of every dollar given to UMCOR goes to help people and their communities. To support UMCOR's long-term disaster recovery work:

- Mark an envelope or check "UMCOR." Then send it to the church or put it in the locked box on the front door of the church office. The church's address is 15653 Newton St, Hacienda Heights, CA 91745.
- Give online at <https://www.stmattsumc.com>. Click on "Donate." Then in the drop down box, choose "UMCOR."



## The Board of Trustees Reports . . .



To Our St. Matthew's UMC Congregation,

I hope you are each doing as well as you can under the circumstances. We are all in this together!

Have you noticed how green the church lawn is? Even with a pandemic, it is important that we keep our church home looking as nice as possible. When the sprinkler timer wasn't working well, Huber Bongolan took it upon himself (even though he's retired) to water so that things don't dry up! He is also weeding the Aney Memorial Prayer Garden and watering around the newly refreshed plants on the perimeters of the parking lot and campus buildings.

Bob Hernandez has informed us that the long-awaited chair lift project is complete! Those who will need to use it, and their care-givers, can get special training from Bob. Thank you, Bob, for seeing this project to fulfillment!

Huber is still recruiting Scouts to plan their Eagle Projects around St. Matthew's to keep our campus updated. The next project will benefit the PreSchool, which is signing up students for their upcoming opening. Thanks, Huber!

Olga Baker and her crew continue the tradition of upgrading the sanctuary banners and accoutrements for each season of our Christian year.

Marilyn McMullin cares for the parsonage needs that may occur.

Dick Cline is still in charge of the landscape upgrading, both at the preschool and at the front of the sanctuary. We want to have it all looking great to show off our campus to students, their parents, and of course, all of our congregation!

The Maxine Singiser account has provided much-needed funding to keep Pastor Richard and many others streaming our Sunday Service with lighting, microphones, cameras, etc. He and Ruth took a well-earned vacation, with Pastor Marta from Ohio filling in. Wasn't it great to see our Bell Choir playing on Sunday, all socially distanced? They looked and sounded terrific!

Please remember, you are helping with the upkeep of our church ministry with your contributions to St. Matthew's.

In His Name,  
*LaVerne Shaffer,*  
Trustees Secretary



## And We Really Did Talk!!

The EIC (Engaging in Conversation) team wants to thank everyone who participated in the recent “Let’s Talk About It” series of conversations. During this three-part series we came together to ask:

- How can racial tensions still be so prevalent?
- When is enough is enough?
- What must be done for meaningful and lasting change?

These conversations deepened awareness of:

- the disregard of the humanity of others (as in the relocation of Japanese Americans to internment camps during World War II),
- the tools of fear, class, policy, and profiling used to maintain the status quo, (as in a black repairman needing to explain his inventory, tools, receipts and being afraid to work at night),
- the ways racism is justified and deflected in daily conversations (as in references to black on black crime, stereotyping, media portrayals).



The Engaging in Conversation team is planning new events to continue this exploration of perceptions and attitudes around race, and how individuals can create lasting change. See you soon!

*Patty Graves*



## 4 Ways to Give to St. Matthew’s

- 1) Mail your gift to the church** at 15653 Newton Street, Hacienda Heights, CA 91745. The church’s mail comes to a secured mailbox.
- 2) Bring your gift to the church.** There is a locked box on the front door of the office. The locked box is checked regularly.
- 3) Give online.** Go to St. Matthew’s website at <https://www.stmattsumc.com> Then, click on “Donate” on the upper right-hand side of the page.
- 4) Text any amount to 84321** to give. Standard message and data rates may apply. Anytime you want to give, you can simply text your donation amount (and fund) to **84321** to initiate an online donation.

Call or email the church office at 626-333-6656 or [office@smumchh.org](mailto:office@smumchh.org) for further instructions of how to “text” your giving.

## San Fernando Valley Refugee Children's Center

A few weeks ago, I wrote an article describing my visit to the San Fernando Valley Refugee Children's Center (Center). The Center is run and sponsored by our sister church, the North Hills United Methodist Church in the San Fernando/North Hills area. The Center offers hope, comfort and love to children seeking refuge from violence in their home country.

In that article I passed on the plea from Pastor Fred Morris for donations to the Center. During this period of Covid-19 the Center has struggled in their fundraising efforts as events and traditional outreach have been hampered by the pandemic.



Let me tell you how the Center operates. It locates the families of those refugee children with known relatives in the Los Angeles area. Then, a representative from the Center travels to the location where the child is held, recovers the child and unites the child with a family member. It then offers them wrap-around services which include psychological evaluations and therapy due to trauma experienced during the trajectory or the violence experienced in their country of origin, or both. The costs for travel for the child and the Center's representative, processing fees charged by for-profit holding agencies, therapy, ongoing legal representation to assist the child in accessing status to remain in the country, and family-child transitioning help are costs paid by the Center. Some costs on a sliding scale, as can be afforded by the family, may be recovered. Unfortunately, these families are for the most part, working poor.

Thank you to the members that contributed to the Center a few months ago when the call for donations first went out via *The ParishScope*. Our congregation is known for its compassion and generosity in donating food, helping the homeless and through UMCOR reaching people around the world. Let's also do the same to help a neighboring sister church that has taken on a challenge worthy of our assistance. To add to the \$400 raised for such a great need, on Sunday, October 18<sup>th</sup>, the church will dedicate the day's offering to help the Center.

You can give 3 ways:

- Send a check marked "Children's Center" or "SFVRCC" to the church at 15653 Newton St, Hacienda Heights, CA
- Drop a check marked "Children's Center" or "SFVRCC" in the locked box on the front door of the office.
- Make an online offering at <https://stmatthewshh.churchcenter.com/>. One of the giving choices in the drop down list is "San Fernando Valley Refugee Children's Center"

In God's grace,  
*Dolores Gonzalez-Hayes*

***Thou shalt open thine hand wide unto thy brother, to thy poor, and to thy needy....***

***– Deuteronomy 15:11b***

**St. Matthew's Continues To Be . . .**

# GATHERING & CONNECTED



## **Zoom the Sunday Morning Adult Sunday School Class**

Adult Sunday School Class has resumed at 8:45 am each Sunday. All are welcome. Several new people have joined the class recently.

The Adult Sunday School Class is under the leadership of Rodney Kurimoto. The class is part way through a study of the history of the Christian movement. You do not need to register in order to come to the class. But, if you do contact Rodney by e-mail or phone, then he can send you helpful material for each week's class. His e-mail is [rkkurimoto@gmail.com](mailto:rkkurimoto@gmail.com). You can get his phone number by calling the church office or looking in the church directory.

The class uses Zoom to listen/watch each week's presentation. Afterwards, there is a class discussion. While the presentation is a video, its content makes sense even if you can only hear it by phone. The notes Rodney sends in advance are particularly helpful to those who are listening by phone.

*If you are coming by phone (i.e. you do not need a computer to come),*

Dial: 1-669-900-6833

Meeting ID: 832 3700 6446#

If asked for a second ID: #

Password: 778913#

*If you are coming by computer, tablet, . . . .*

Go to <https://zoom.us/join>

Meeting ID: 832 3700 6446

Password: 778913

You can also e-mail the church office for a link at [office@smumchh.org](mailto:office@smumchh.org)

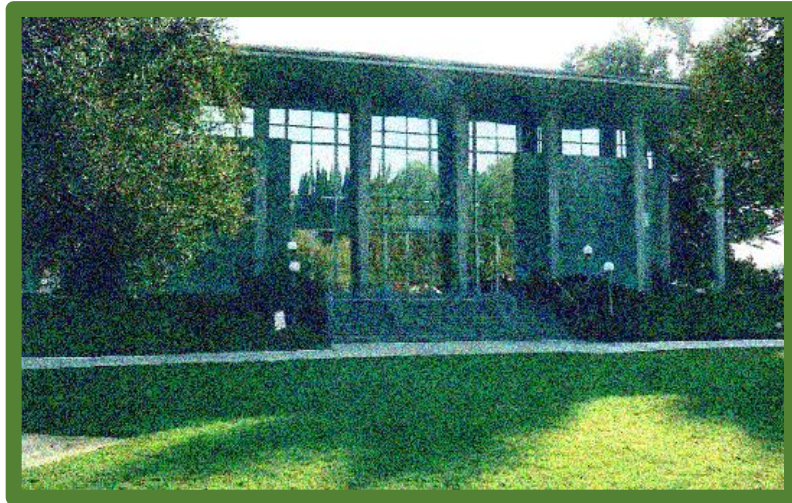

## How to Join Us for Worship Services on Sunday Mornings

**Join us for worship starting at 9:55 am each Sunday morning:**

**1) Go to the church's Facebook page at**

<https://www.facebook.com/Stmatts1/>

(You do *NOT* need to belong to Facebook to do this)

**2) Go to a special page on the church's website.** (This page *only* works when a Facebook live service is happening)

<https://www.stmattsumc.com/facebook-live/>

**During the week, the easiest way to join the worship service** is by going to the church's website and click on "Recent Services" <https://www.stmattsumc.com>

## Worshipping - On Your Landline Phone!!

People in the church family can now come to church on Sunday morning at 9:55 am by using their landline phone. That's right, you don't need a computer or internet access. All you need is a regular phone.

Judy Vroman is hosting the gathering of people coming to the church service by phone. You can call in starting at 9:50 am. You can spend a few moments chatting with Judy before the service starts at 9:55. Unlike the online worship, this service only happens live. So you can only come during the actual time the worship service is happening on Sunday morning.

To come to church using a regular phone:

Dial: 1-669-900-6833

Enter Meeting ID: 820 9058 2853#

If asked for a participant ID, enter: #

Passcode: 287674#

Contact Judy Vroman if you have questions, need additional information or have problems connecting by phone on Sunday morning.





## How to Connect with Online Worship

For the complete, detailed instruction on how to view St. Matthew's Sunday Services Live – or to view previously recorded Worship Services at any time you like – please contact the Church Office. Email your request to [office@smumchh.org](mailto:office@smumchh.org) or call 626-333-6656. We will be glad to mail or email you complete instructions.

*Louise, Office Administrator*

## Online Communion at St. Matthew's



The first Sunday of each month at St. Matthew's is Communion. Some gather for communion starting at 9:55 am on Sunday to take communion as the worship service is happening. Others join later in the week. Whenever you may come, please prepare the following in advance:

- *A plate with something to eat.* This might be a piece of bread, cracker, roll, tortilla, muffin . . .
- *A cup or glass of something to drink.* This might be juice, water, tea, coffee, . .

You can watch Pastor Richard's brief video about online communion at:

<https://www.facebook.com/Stmatts1/videos/2408574115909743>

You do *not* need to belong to Facebook in order to watch the video of Pastor Richard.



## Wednesday Worship Evolves at the Palms

Wednesday Worship at the Palms in La Mirada keeps happening each week at 3:00 pm. But, how the group meets has changed. Now the group gathers by phone instead of in person. The gathering begins with a time to check in and talk. Recently, someone has started sharing a few jokes or riddles. Johnny Doyle continues to share a song each week. Then, there is brief reading from the Bible. But now instead of a "sermon", the whole group discusses the Bible Reading. Afterwards, each person is invited to share any prayer requests they have. The service ends with a prayer time and the Lord's Prayer.

Since very few people at the Palms have internet access, people gather in a group phone call. To learn how to come to the service by phone – either with a landline or a mobile phone – contact the church office 626-333-6656 or Pastor Richard on his cell phone, 626-261-1428.

## Chancel Choir and Carillon Ringers Continue to Get Together via Zoom



St. Matthew's Chancel Choir and Carillon Ringers have been "getting together" via Zoom conferencing. We get together on Thursdays as we usually do when we are rehearsing for Sunday Worship.

If anyone else would like to join and socialize with the choir and bell ringers – we would love it! We "meet" every other Thursday at 3:00pm. In October we "meet" on October 8<sup>th</sup> and October 22<sup>nd</sup>.

To Join Zoom Meeting:

<https://us02web.zoom.us/j/82716181867?pwd=N0VVdEZPRVd5VmhJTINmMFBJSmJvQT09>

Meeting ID: 827 1618 1867

Password: 536478

One tap mobile

+16699006833,,82716181867#,,1#,536478# US (San Jose)

+13462487799,,82716181867#,,1#,536478# US (Houston)

Dial by your location

+1 669 900 6833 US (San Jose)

+1 346 248 7799 US (Houston)

+1 253 215 8782 US (Tacoma)

+1 929 205 6099 US (New York)

+1 301 715 8592 US (Germantown)

+1 312 626 6799 US (Chicago)

Meeting ID: 827 1618 1867

Password: 536478

Hope everyone is staying cool, getting some exercise, eating well, and finding ways to be happy and connected during these uncertain times.

*Elaine Ono*



## Nifty After Fifty "Get Together" Again Via Zoom

The Nifty After Fiftys are getting together again via Zoom. They finally "got together" in September after a hiatus from the COVID quarantine. They will be "getting together" again - nothing formal planned, just a time to share.

Contact Judy and Larry Vroman at [jgvroman@msn.com](mailto:jgvroman@msn.com) to find out about the next "get together".



## Women's Breakfast Group Gets Together

We had a small but mighty group that met on Wednesday, September 30<sup>th</sup>. We talked for 2 hours!!!! What would we do

without our great group of gals enjoying the closeness that only women can have. But we could add more to our group and double our pleasure.

All Ladies are welcome to join us every Wednesday on Zoom starting at 8:30 a.m. until 10:00. Call Joy for the link to get on at 909-784-8085 or [joyfeulner@verizon.net](mailto:joyfeulner@verizon.net).

You are certainly welcome to be part of this group of women who live and care for each other. Our talks cover any topic you can imagine. And if you have something that interests you, you are welcome to share.



*Joy Feulner*



## Men's Breakfast

Every Thursday, we get together for a cup of coffee (formerly breakfast) on-line. It's a great opportunity to stay connected with friends and with what's going on at Church. So next time 8 O'Clock Thursday rolls around, drop in on our Zoom meeting — there's plenty of room for more! Go to [www.zoom.us](http://www.zoom.us). Use the Meeting ID: 638 574 0531, Password: 118405. Or, if your computer has no video camera, just call in: 1-669-900-6833. Contact David Crain at [davidwcrain@aol.com](mailto:davidwcrain@aol.com) for more information.

*David Crain*

## Women – An Invite to Join the Shalom Group

Dear Women of St. Matthew's,

A group of women meet at church out in the fresh air every Monday morning at 9:30 a.m. We select books to study and discuss, with some laughter included too. We would like to see our group grow. We welcome all, come join us!



- *Sharon Kline*





## Celebrating October Birthdays

<b>Oct. 3</b>	<b>Robert Reid</b>
<b>Oct. 9</b>	<b>Rosalie Bongolan</b>
<b>Oct. 10</b>	<b>Shirley Butler</b>
<b>Oct. 11</b>	<b>Pastor Richard Bentley</b>
<b>Oct. 13</b>	<b>Pastor Joshua Kohr (Pastor BCUMC)</b>
<b>Oct. 19</b>	<b>Chris Gallagher</b> <b>Gene Logan</b> <b>Grace Ham (Resident @ The Palms)</b>
<b>Oct. 20</b>	<b>Mary Feiner (Resident @ The Palms)</b>
<b>Oct. 21</b>	<b>Huber Bongolan</b>
<b>Oct. 24</b>	<b>Wes Brown</b>
<b>Oct. 28</b>	<b>Rodney Kurimoto</b> <b>John Elliott</b>
<b>Oct. 30</b>	<b>Larry Vroman</b> <b>Sau Ying Chung</b>



## Celebrating October

<b>October 1<sup>st</sup></b>	<b>Ian and Carol Rogers</b>
<b>October 6<sup>th</sup></b>	<b>Jerry and Marilyn Lutjens</b>
<b>October 7<sup>th</sup></b>	<b>Roger and Julie Williams</b>
<b>October 25<sup>th</sup></b>	<b>Sau Ying Chang &amp; Jimmy Ang</b>



# St. Matthew's United Methodist Church

	Monday	Tuesday	Wed.	Thursday	Friday	Saturday
				1 8:00am - Men's Breakfast 10:30-"Praying for Jennifer" Class 6:00pm - Bells Rehearsal	2	3
4 <b>World Communion Sunday</b>  8:45 - Adult Sunday School 9:55am - Worship	5 9:30am - Shalom	6 7pm-Trustees Meeting	7 8:30am - Women's Breakfast 3:00pm - <i>The Palms</i>	8 8:00am - Men's Breakfast 10:30- "Praying for Jennifer" Class 3:00pm - Online Choir & Bells Social Time 6:00pm - Bells Rehearsal	9	10
11 8:45 - Adult Sunday School 9:55am - Worship 	12 9:30am - Shalom	13 7pm - SPRC	14 8:30am - Women's Breakfast 3:00pm - <i>The Palms</i>	15 8:00am - Men's Breakfast 10:30-"Praying for Jennifer" Class 6:00pm - Bells Rehearsal	16	17
18 8:45 - Adult Sunday School 9:55am - Worship  Car Parade - Gather @ 4:45pm then leave @ 5:00pm	19 9:30am - Shalom	20	21 8:30am - Women's Breakfast 3:00pm- <i>The Palms</i>	22 8:00am - Men's Breakfast 4:00pm - Bells Zooming on Church's Front Lawn	23	24
25 At 5:00 p.m. View on St. Matthew's Facebook ... <b>CONCERT - RANDY GUIAYA &amp; BILLY BURKE</b> 	26 9:30am - Shalom	27	28 8:30am - Women's Breakfast 3:00pm - <i>The Palms</i>	29 8:00am - Men's Breakfast 6:00pm - Bells Rehearsal	30	31 



### TO VIEW OUR WORSHIP SERVICES:

Go to <https://www.facebook.com/pg/Stmatts1>. You can also view past services by going to <https://www.stmattsumc.com/facebook-live-test/> then click on the service you want.

### We continue to keep in touch:

- Every Monday morning at 9:30 a.m. - *Shalom*
- Every Wednesday morning at 8:30 a.m. - *Women's Breakfast Group*.
- Every Thursday morning at 8:00 a.m. - *Men's Breakfast Bunch*.
- Trustees* - First Tuesday of the month at 7:00 p.m. each month.
- SPRC* (Staff Parish Relations) - 2<sup>nd</sup> Tuesday of the month at 7:00 p.m.
- Church Council* - 3<sup>rd</sup> Thursday of each month at 7:30 p.m.
- Finance Committee* - to be determined.
- Small Groups also keep in touch by phone during the week.

Be sure to call or email the Church Office with any questions about meetings, classes, or "get togethers" at 626-333-6656 or [office@smumchh.org](mailto:office@smumchh.org).

## Humor and Ponderings



Old picture of people eating in a restaurant back in 2019



When you're cooking & the recipe says "chill in the fridge for one hour"

*Hey Pooh?  
Yes Piglet?  
This thing seems to be going on forever.  
You mean the pandemic thing?  
Yeah, will it ever end?  
Oh I hope so Piglet.  
I do too, I miss so much.  
What do you miss?  
Hugs Pooh, I miss hugs.  
Yeah, its the one thing the humans were good at  
I know Piglet,  
I know*

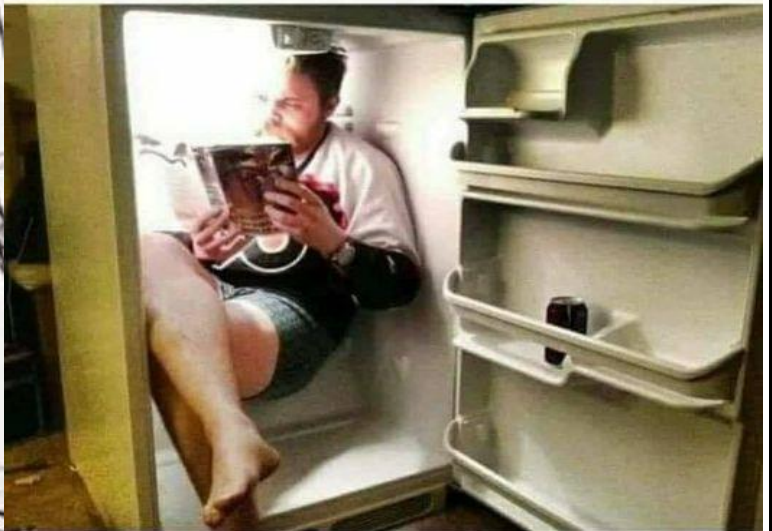
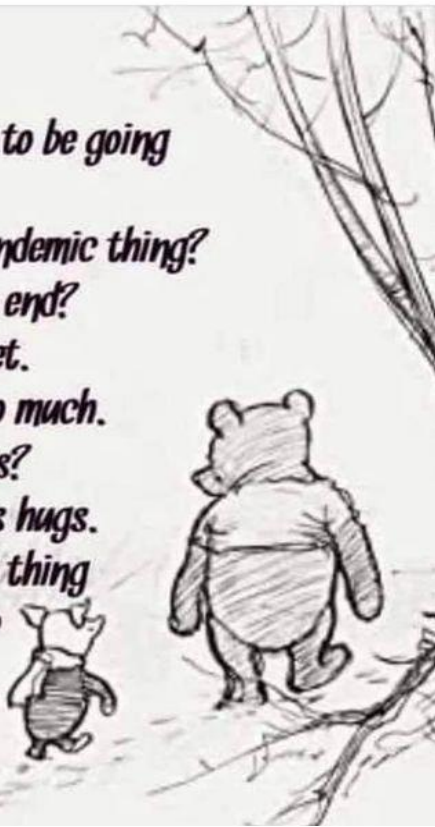

Friendly reminder that "doing your best" does not mean working yourself to the point of a mental breakdown.

@Peace[un]likePeace[un]like

**Peace is not when everyone agrees. It is when we can respect our disagreements and still play in the sandbox together.**

When this is over,  
may we never again  
take for granted  
A handshake with a stranger  
Full shelves at the store  
Conversations with neighbors  
A crowded theatre  
Friday night out  
The taste of communion  
A routine checkup  
The school rush each morning  
Coffee with a friend  
The stadium roaring  
Each deep breath  
A boring Tuesday  
Life itself.

When this ends,  
may we find  
that we have become  
more like the people  
we wanted to be  
we were called to be  
we hoped to be  
and may we stay  
that way—better  
for each other  
because of the worst.

*-written by Laura Kelly Fanucci*



**ST. MATTHEW'S UNITED METHODIST CHURCH**

**15653 E. Newton Street, Hacienda Heights, CA 91745**

**Phone: 626-333-6656      Email: [Office@smumchh.org](mailto:Office@smumchh.org)**

Rev. Richard Bentley, Pastor      Louise Green, Office Administrator      Elaine Ono, Director of Music  
Greg Gomez, Custodian      Morgan Matthews, Sound Technician  
Sherry Morales, Director of Preschool, 626-330-8340, [www.smumpc.org](http://www.smumpc.org)

**FIRST CLASS MAIL**

**St. Matthews United Methodist Church  
15653 E. Newton Street  
Hacienda Heights, CA 91745**

